

Open Print Standard - Job Ticket API (JTAPI)

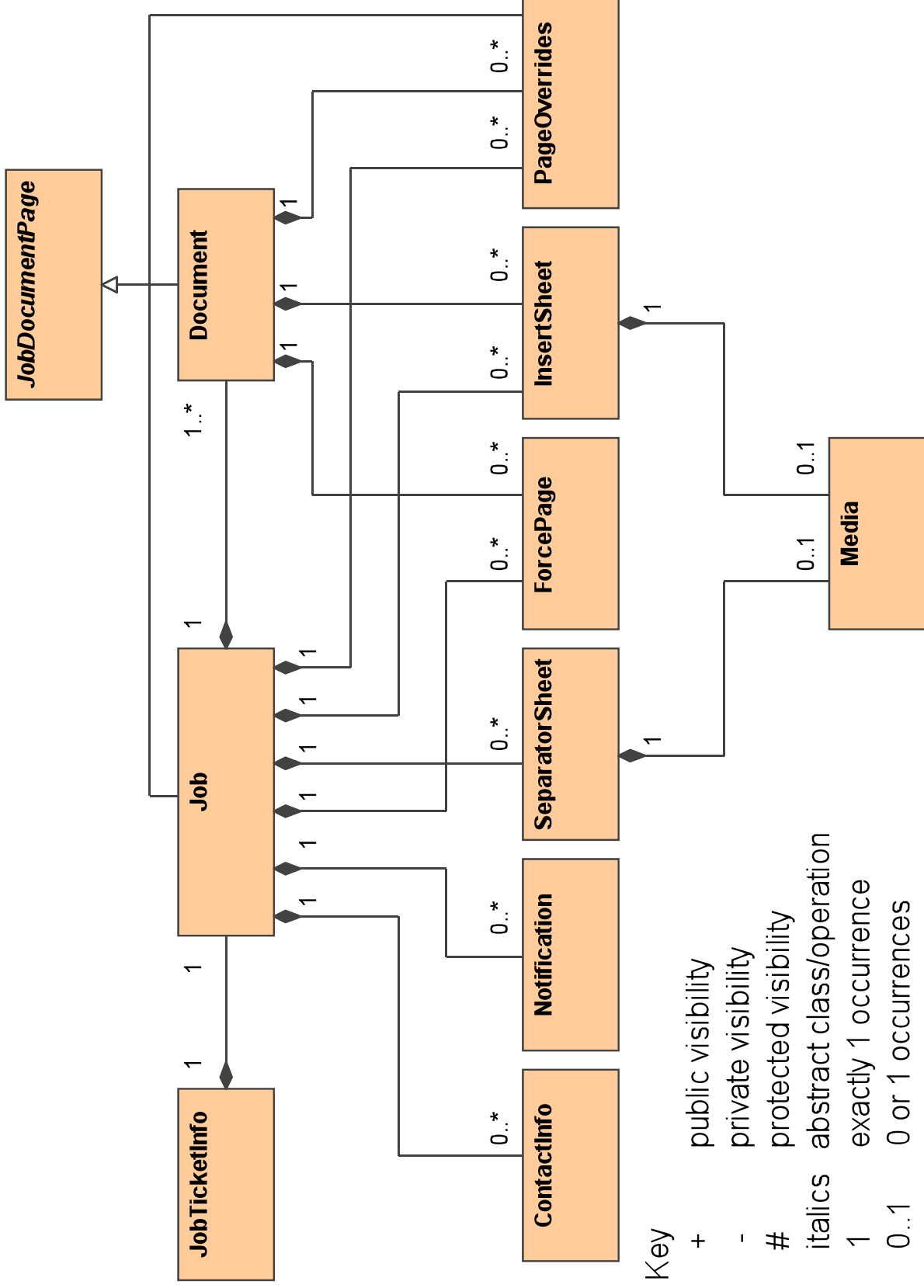

Attribute is used by all classes that have get and set operations.

Attribute
-name : text
-type : ValueTypeEnum
-values : list
+Attribute(name : text, type : ValueTypeEnum, values : list) : Attribute
+getName() : text
+getValueType() : ValueTypeEnum
+hasNextValue() : boolean
+nextValue() : value of type ValueTypeEnum
+~Attribute()

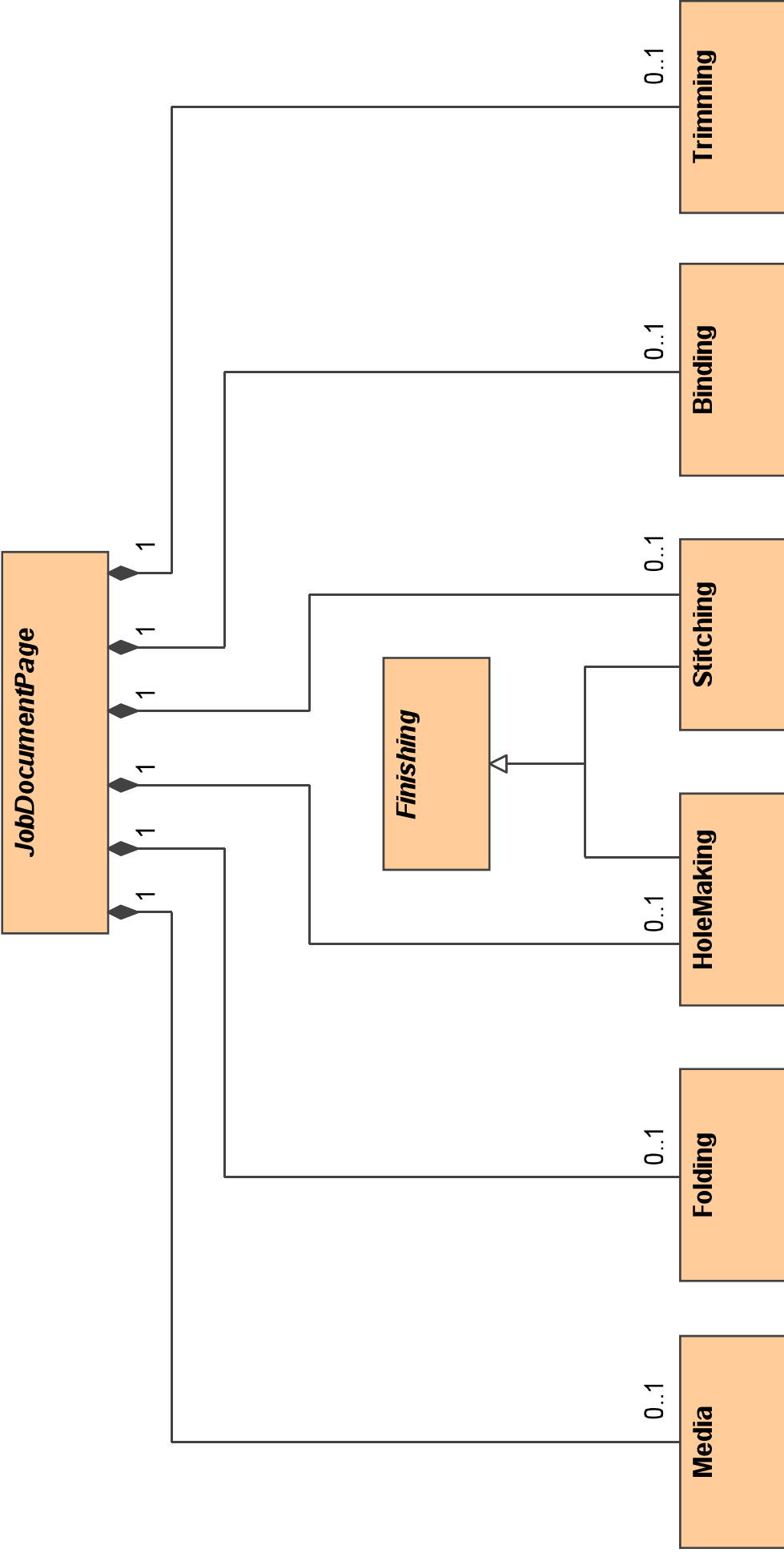

Valid get/set attributes:
 jf-api-charset
 jf-api-version
 jf-author-name
 jf-charset
 jf-comment
 jf-id
 jf-mandatory-attributes
 jf-syntax-version
 jf-type
 jf-version

For Version 1.0 of the JTA API, the following will not be included in the implementation:
 -- Attributes denoted by -- and their associated data members

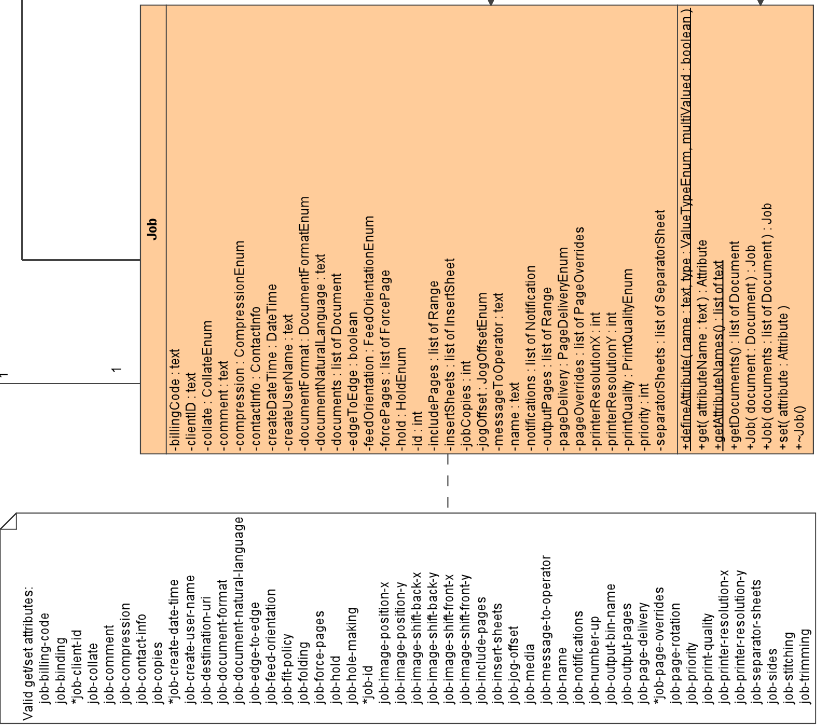
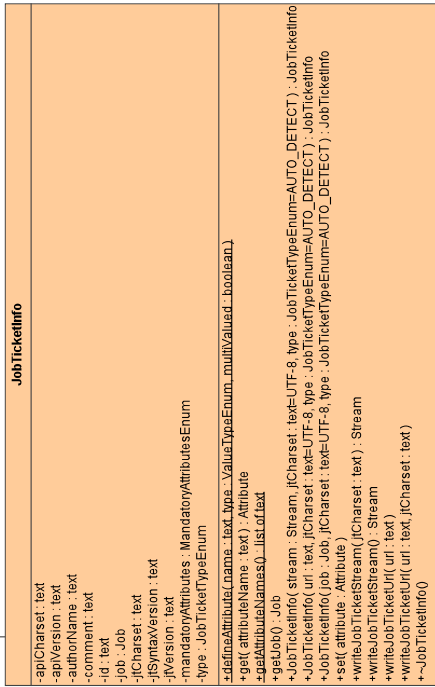

Valid get/set attributes:
 *document-binding
 *document-compression
 *document-copies
 *document-destination-uri
 *document-feed-orientation
 *document-folding
 *document-force-pages
 *document-format
 *document-jog-offset
 *document-hole-making
 *document-image-position-x
 *document-image-position-y
 *document-image-shrink-back-x
 *document-image-shrink-back-y
 *document-image-shrink-front-x
 *document-image-shrink-front-y
 *document-insert-sheets
 *document-include-pages
 *document-media
 *document-natural-language
 *document-number-up
 *document-output-bin-name
 *document-output-pages
 *document-page-overrides
 *document-page-rotation
 *document-print-quality
 *document-sides
 *document-stitching
 *document-trimming
 document-uri

Valid get/set attributes:
 *no-binding
 *no-destination-uri
 *no-fit-policy
 *no-folding
 *no-hole-making
 *no-image-position-x
 *no-image-position-y
 *no-image-shrink-back-x
 *no-image-shrink-back-y
 *no-image-shrink-front-x
 *no-image-shrink-front-y
 *no-media
 *no-number-up
 *no-output-bin-name
 *no-page-rotation
 *no-pages
 *no-sides
 *no-stitching
 *no-trimming

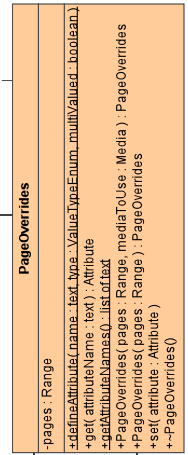

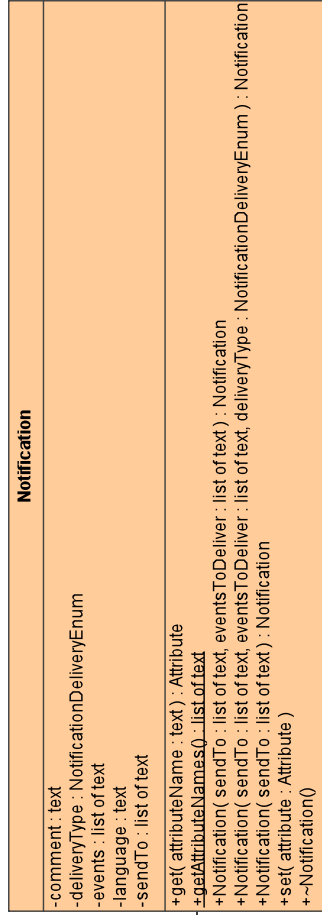
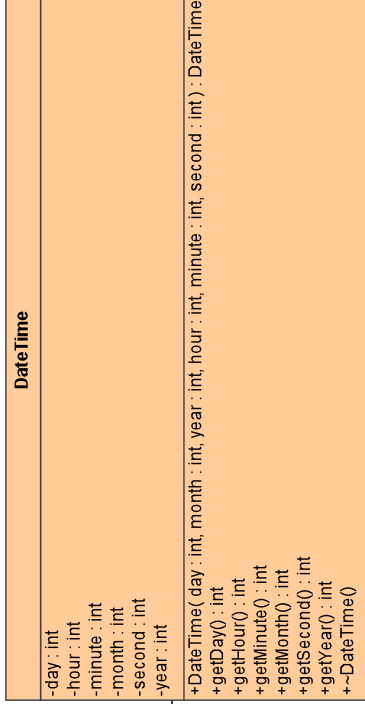

Valid get/set attributes:
 notification-comment
 notification-delivery-type
 notification-events
 notification-language
 notification-send-to

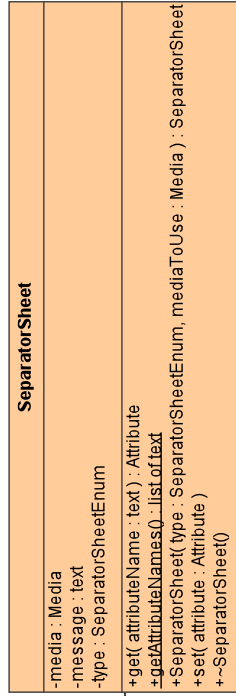

Valid get/set attributes:
 separator-sheet-media
 separator-sheet-message
 separator-sheet-type

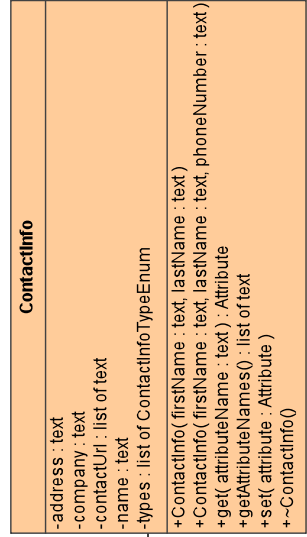
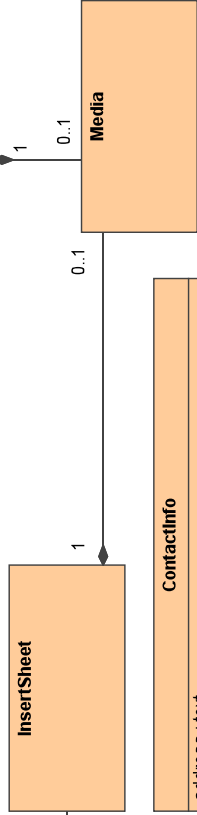

Valid get/set attributes:
 contact-info-address
 contact-info-company
 contact-info-contact-url
 contact-info-name
 contact-info-types



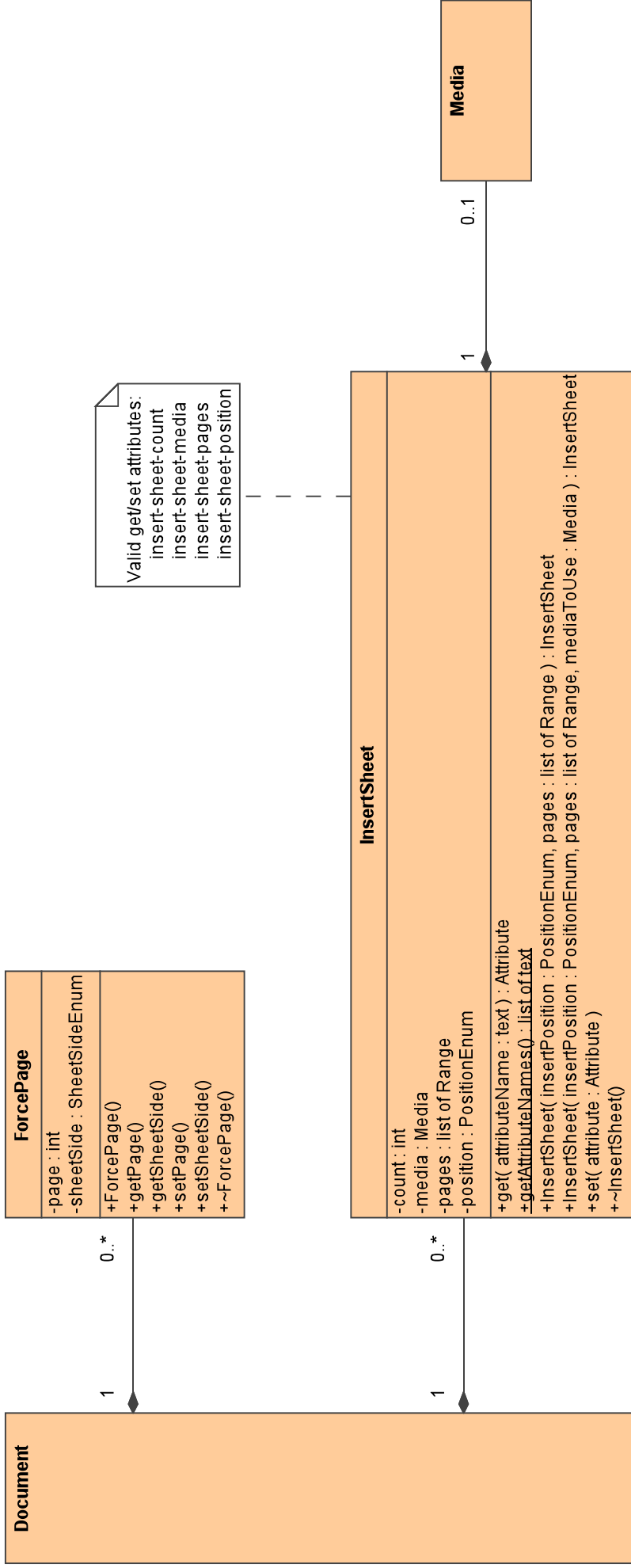

PageOverrides

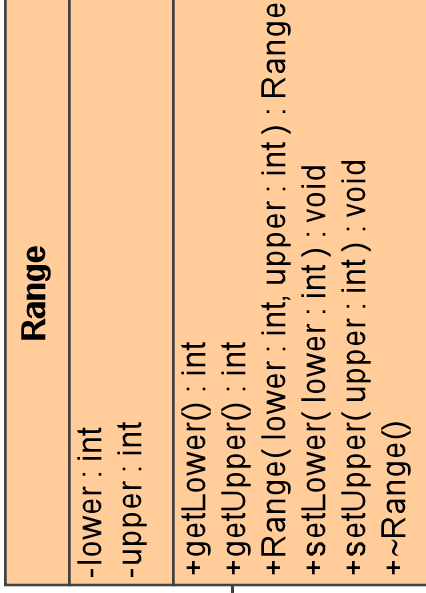

1 1



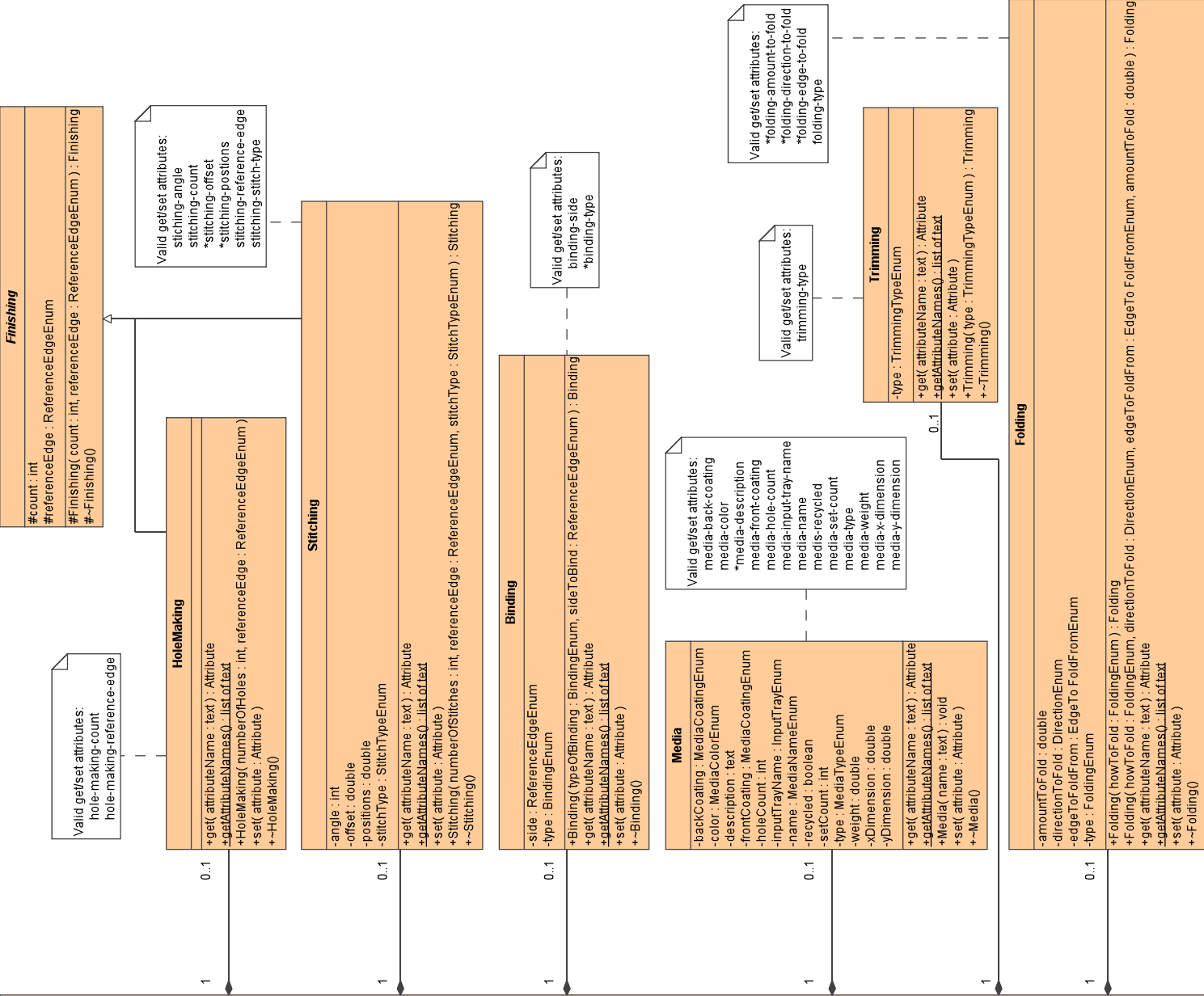

Enumerations that are text so they are extensible:

BindingEnum
 DocumentFormatEnum
 FoldingEnum
 HoldEnum
 InputTrayEnum
 JobTicketTypeEnum
 MandatoryAttributesEnum
 MediaColorEnum
 MediaNameEnum
 MediaTypeEnum
 NotificationDeliveryEnum
 NumberUpEnum
 OutputBinEnum
 ValueTypeEnum

Enumerations that are integers so they are not extensible:

CollateEnum
 CompressionEnum
 ContactInfoTypeEnum
 DirectionEnum
 EdgeToFoldFromEnum
 FeedOrientationEnum
 FitPolicyEnum
 ImagePositionEnum
 JogOffsetEnum
 MediaCoatingEnum
 PageDeliveryEnum
 PositionEnum
 PrintQualityEnum
 ReferenceEdgeEnum
 RotationEnum
 SidesEnum
 SeparatorSheetEnum
 SheetSideEnum
 StitchTypeEnum
 TrimmingTypeEnum

<<enumeration>> BindingEnum
TAPE
PERFECT
NONE

<<enumeration>> CollateEnum
SHEET
SHEET_AND_JOB
NONE
NOT_SET

<<enumeration>> CompressionEnum
NOT_SET
NONE
COMPRESS
DEFLATE
GZIP

<<enumeration>> ContactInfoTypeEnum
NOT_SET
ADMINISTRATOR
ACCOUNTING
CUSTOMER
DELIVERY
PICKUP
SUPPLIER
SURPLUS_RETURN
ART_RETURN

<<enumeration>> DirectionEnum
DOWN
UP
NOT_SET

<<enumeration>> DocumentFormatEnum
AFPS
ASCII
PCL
PDF
PS
TEXT
PCL6
OTHER
PPML

<<enumeration>> EdgeTo FoldFromEnum
FRONT
LEFT
NOT_SET

<<enumeration>> FeedOrientationEnum
NOT_SET
LONG_EDGE_FIRST
SHORT_EDGE_FIRST

<<enumeration>> FitPolicyEnum
NOT_SET
FIT_TO_PAGE
CLIP_TO_MAX_PAGE

<<enumeration>> FoldingEnum
Z
SADDLE
CUSTOM
NONE

<<enumeration>> HoldEnum
NOT_SET
NO_HOLD
INDEFINITE

<<enumeration>> ImagePositionEnum
NOT_SET
NONE
BOTTOM
CENTER
LEFT
RIGHT
TOP

<<enumeration>> InputTrayEnum
ALTERNATE
AUTO_ENVELOPE_FEED
AUTOMATIC_TRAY
AUTO_SELECT
AUXILIARY_ENVELOPE
AUXILIARY_PAPER
BOTTOM
CAPACITY_2000_SHEET
CONTINUOUS_FORM_FEED
CURRENT_SELECTED_TRAY
ENVELOPE
HIGH_CAPACITY_FEEDER
LARGE_CAPACITY
MAIN
MANUAL
MANUAL_ENVELOPE_FEED
MIDDLE
TOP
TRAY_1
TRAY_2
TRAY_3
SIDE

<<enumeration>> JobTicketTypeEnum
JDF
PWG
AUTO_DETECT

<<enumeration>> JogOffsetEnum
BETWEEN_JOB_COPIES
BETWEEN_JOBS
BETWEEN_JOB_COPIES_AND_JOBS
NONE
NOT_SET
BETWEEN_DOC_COPIES
BETWEEN_DOC_COPIES_AND_DOCS

<<enumeration>> MandatoryAttributesEnum
NONE
ALL

<<enumeration>> MediaCoatingEnum
NOT_SET
GLOSS
HIGH_GLOSS
MATTE
SATIN
SEMI_GLOSS
NONE

<<enumeration>> MediaColorEnum
BLACK
BLUE
BROWN
BUFF
GOLD
GOLDENROD
GRAY
GREEN
IVORY
MULTI_COLOR
MUSTARD
NO_COLOR
ORANGE
PINK
PURPLE
RED
SILVER
TURQUOISE
USER_COLOR
VIOLET
WHITE
YELLOW
Each of the above with a DARK_ prefix
Each of the above with a LIGHT_ prefix

<<enumeration>> NotificationDeliveryEnum
EMAIL
WRITE_TO_FILE
ADD_TO_FILE
JOB_LOG
MESSAGE
NONE

<<enumeration>> PositionEnum
AFTER
BEFORE
NOT_SET

<<enumeration>> SheetSideEnum
FRONT
BACK
NOT_SET

<<enumeration>> ValueTypeEnum
BOOLEAN
COLLATE_ENUM
DOCUMENT_FORMAT_ENUM
INTEGER
JOG_OFFSET_ENUM
NOTIFICATION_DELIVERY_ENUM
POSITION_ENUM
RANGE
REFERENCE_EDGE_ENUM
SEPARATOR_SHEET
SIDES_ENUM
SHEET_SIDE_ENUM
STITCH_TYPE_ENUM
STRING
FOLDING
DIRECTION_ENUM
EDGE_TO_FOLD_FROM_ENUM
DOUBLE
JT_TYPE_ENUM
NUMBER_UP_ENUM
PAGE_DELIVERY_ENUM
ROTATION_ENUM
DATE_TIME
INSERT_SHEET
MEDIA
NOTIFICATION
PAGE_OVERRIDES
HOLE_MAKING
STITCHING
BINDING
INPUT_TRAY_ENUM
MANDATORY_ATTRIBUTES_ENUM
MEDIA_COLOR_ENUM
MEDIA_NAME_ENUM
MEDIA_TYPE_ENUM
OUTPUT_BIN_ENUM
COMPRESSION_ENUM
FIT_POLICY_ENUM
IMAGE_POSITION_ENUM
MEDIA_COATING_ENUM
PRINT_QUALITY_ENUM
SEPARATOR_SHEET_ENUM
FOLDING_ENUM
HOLD_ENUM
BINDING_ENUM
TRIMMING_TYPE_ENUM
FEED_ORIENTATION_ENUM

<<enumeration>> PrintQualityEnum
NOT_SET
DRAFT
HIGH
NORMAL

<<enumeration>> SidesEnum
ONE_SIDED_BACK_FLIP_X
ONE_SIDED_BACK_FLIP_Y
ONE_SIDED_FRONT
TWO_SIDED_FLIP_X
TWO_SIDED_FLIP_Y
NOT_SET

<<enumeration>> StitchTypeEnum
CORNER
SADDLE
SIDE
NONE
NOT_SET

<<enumeration>> TrimmingTypeEnum
NOT_SET
NONE
ON

<<enumeration>> ReferenceEdgeEnum
BOTTOM
LEFT
RIGHT
TOP
NOT_SET

<<enumeration>> RotationEnum
0_DEGREES
180_DEGREES
270_DEGREES
90_DEGREES
NOT_SET

<<enumeration>> SeparatorSheetEnum
AFTER_JOB
BETWEEN_DOC_COPIES
AFTER_EACH_DOC_COPY
BEFORE_JOB
BEFORE_EACH_DOC_COPY
BETWEEN_JOB_COPIES
NOT_SET

<<enumeration>> NumberUpEnum
1_Y_AXIS_1_X_AXIS
1_Y_AXIS_2_X_AXIS
2_Y_AXIS_2_X_AXIS

<<enumeration>> OutputBinEnum
BOTTOM
FACE_DOWN
FACE_UP
LARGE_CAPACITY
LEFT
MIDDLE
RIGHT
SIDE
STACKER_1
STACKER_2
STACKER_3
SYSTEM_DEFINED
TOP
TRAY_1
TRAY_2
TRAY_3
UPPER
MAIN

<<enumeration>> MediaNameEnum
A3
A4
A4_TAB
A5
B4
B4_JIS
EXECUTIVE
FOLIO
LEDGER
LETTER
LETTER_TAB
STATEMENT
10_X_14_IN
10_X_15_IN
8_X_10_IN
8_X_10_5_IN
8_X_13_IN
8_25_X_13_IN
170_X_210_MM
182_X_210_MM
CUSTOM
LEGAL

<<enumeration>> MediaTypeEnum
FULL_CUT_TABS
LETTER_HEAD
PAPER
PRE_CUT_TABS
STATIONERY
TAB_STOCK
TRANSPARENCY

<<enumeration>> PageDeliveryEnum
SAME_ORDER_FACE_UP
SAME_ORDER_FACE_DOWN
REVERSE_ORDER_FACE_UP
REVERSE_ORDER_FACE_DOWN
NOT_SET